

Data Sheet

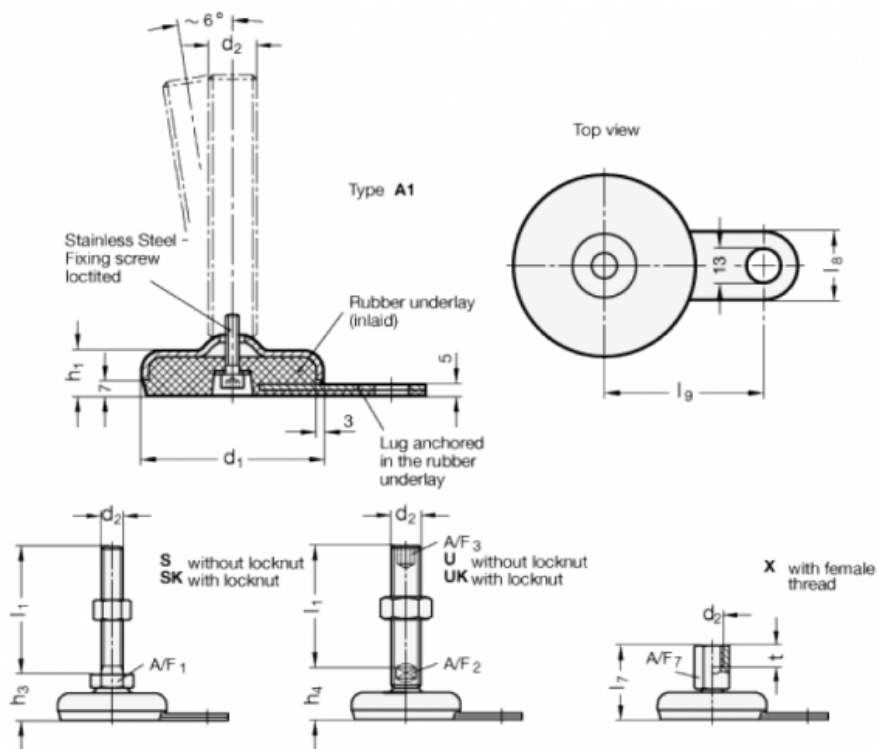

Article number: 203260M1044A1X
 Description: E+G levelling foot
 GN 32-60-M10-44-A1-X
 Note: X With female thread, External hexagon

Measures



A/F7	=	14
d1	=	60
d2	=	M10
h1	=	19
l7	=	44
l8	=	25
l9	=	50
t	=	10